

REFERENCIA: PKAB020000000

POTENCIA: 5,70 kWp

Nº MÓDULOS: 15

PLAZAS: 2



URVEN PARK - H

PILAR DE HORMIGÓN

GRIS OSCURO

VELA DE ACERO

EPOXI POLIAMIDA + POLIURETANO

ALIFATICO BLANCO BRILLO

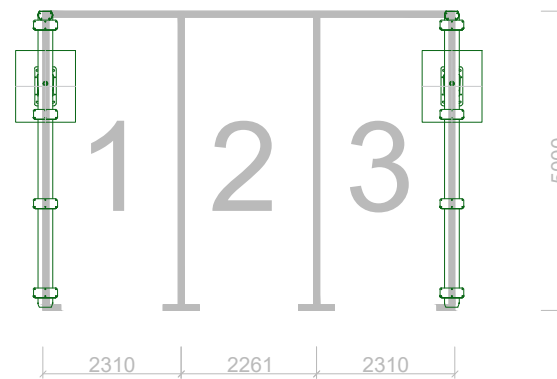
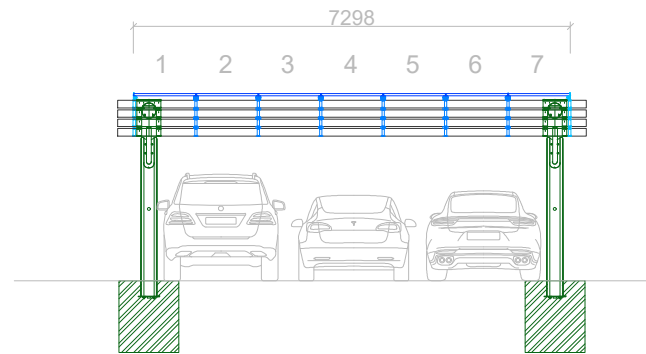
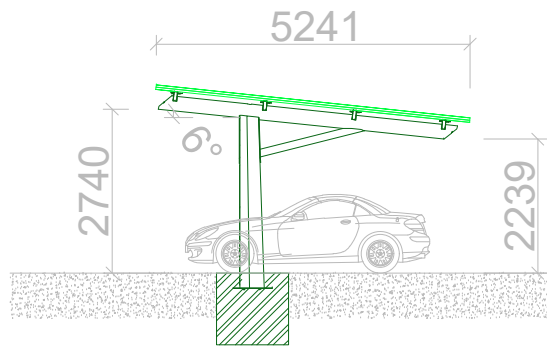

REFERENCIA: PKAB030000000

POTENCIA: 7,98 kWp

Nº MÓDULOS: 21

PLAZAS: 3



URVEN PARK - H

PILAR DE HORMIGÓN

GRIS OSCURO

VELA DE ACERO

EPOXI POLIAMIDA + POLIURETANO

ALIFATICO BLANCO BRILLO

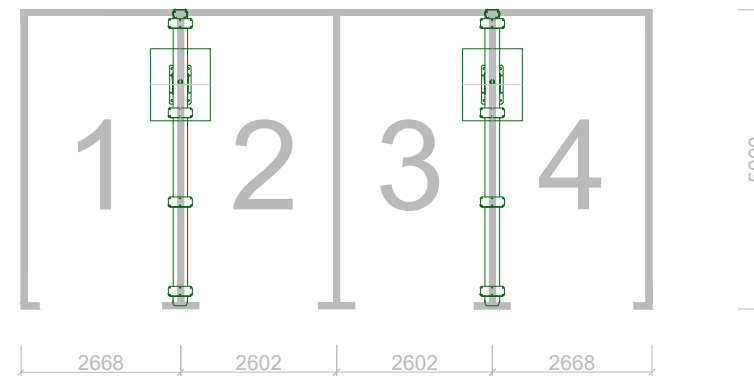
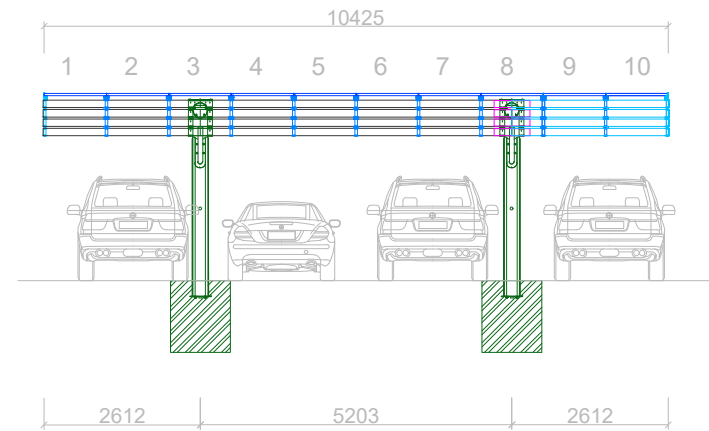
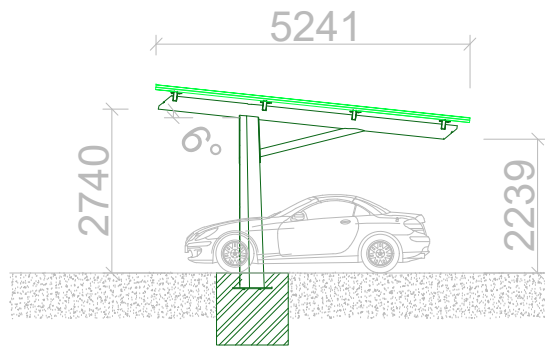

REFERENCIA: PKAB040000000

POTENCIA: 11,40 kWp

Nº MÓDULOS: 30

PLAZAS: 4



URVEN PARK - H

PILAR DE HORMIGÓN

GRIS OSCURO

VELA DE ACERO

EPOXI POLIAMIDA + POLIURETANO

ALIFATICO BLANCO BRILLO

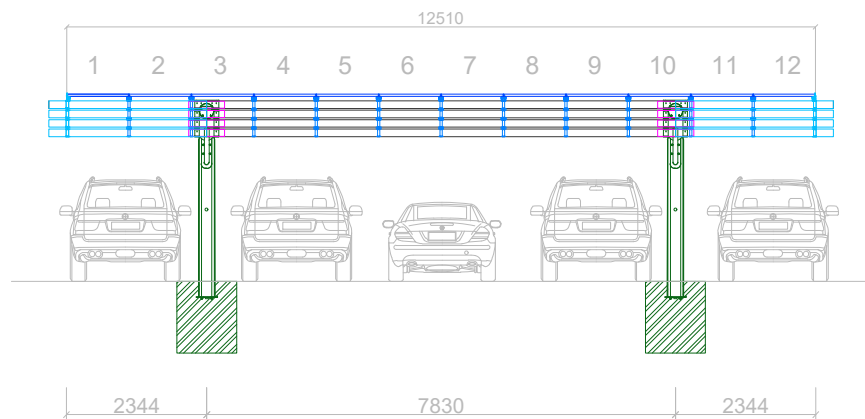
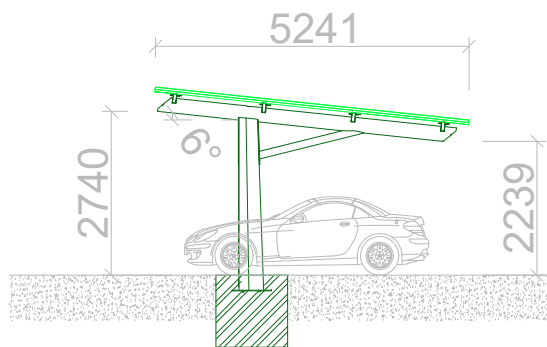

REFERENCIA: PKAB050000000

POTENCIA: 13,68 kWp

Nº MÓDULOS: 36

PLAZAS: 5

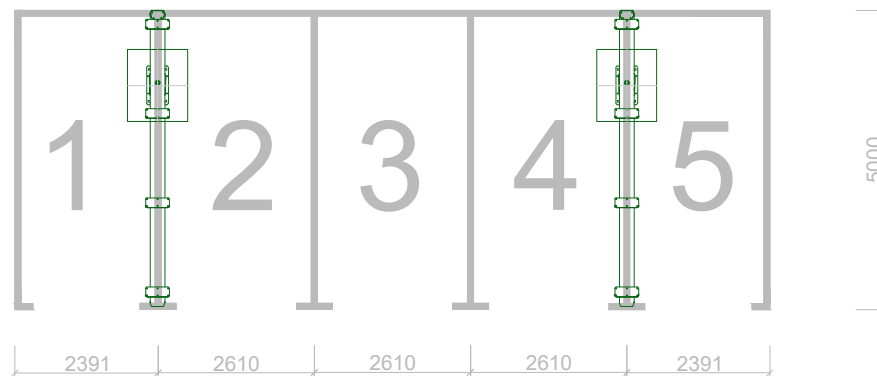

URVEN PARK - H

PILAR DE HORMIGÓN

GRIS OSCURO

VELA DE ACERO

EPOXI POLIAMIDA + POLIURETANO

ALIFATICO BLANCO BRILLO

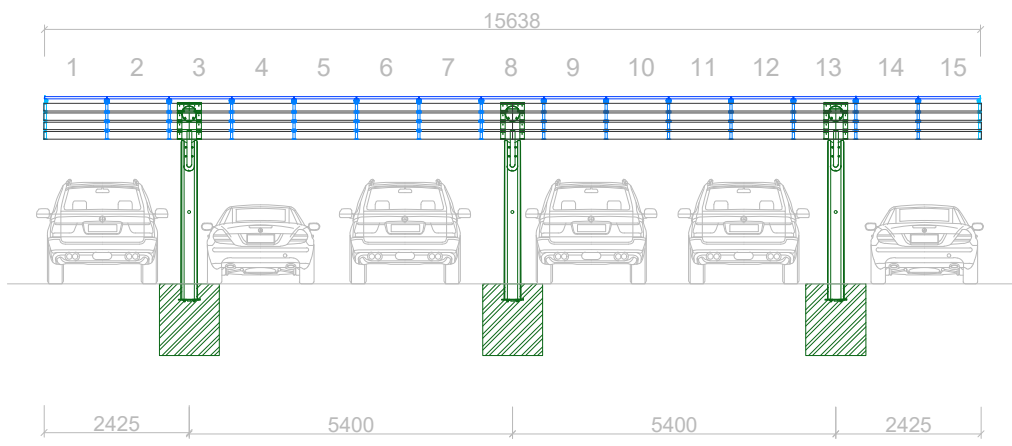
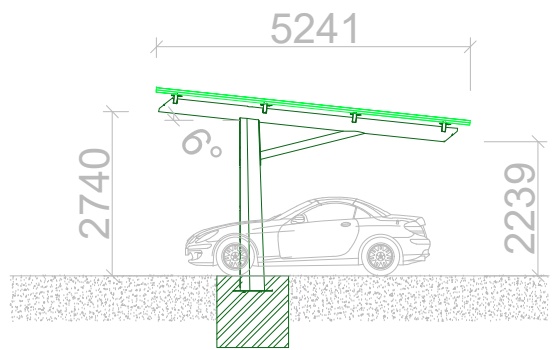

REFERENCIA: PKAB060000000
 POTENCIA: 17,10 kWp
 Nº MÓDULOS: 45
 PLAZAS: 6

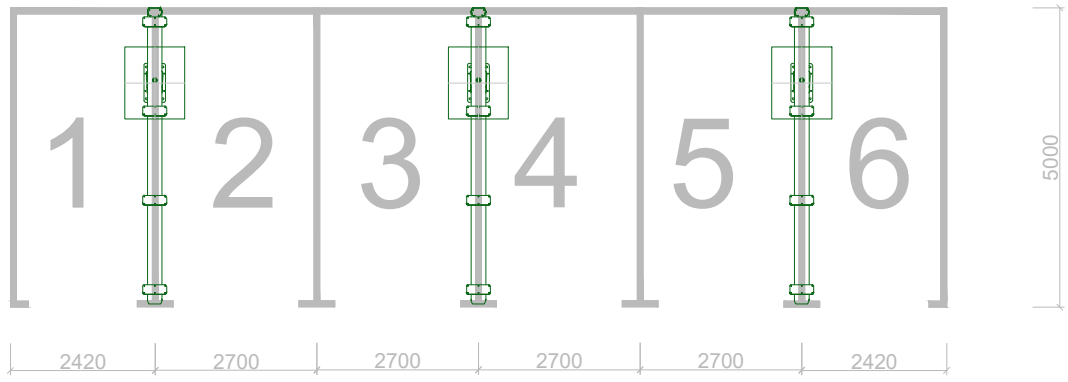

URVEN PARK - H

PILAR DE HORMIGÓN
 GRIS OSCURO
 VELA DE ACERO
 EPOXI POLIAMIDA + POLIURETANO
 ALIFATICO BLANCO BRILLO

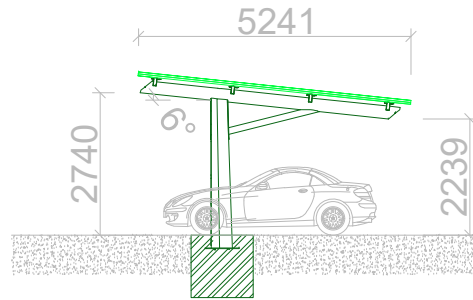

REFERENCIA: PKAB080000000

POTENCIA: 22,80 kWp

Nº MÓDULOS: 60

PLAZAS: 8

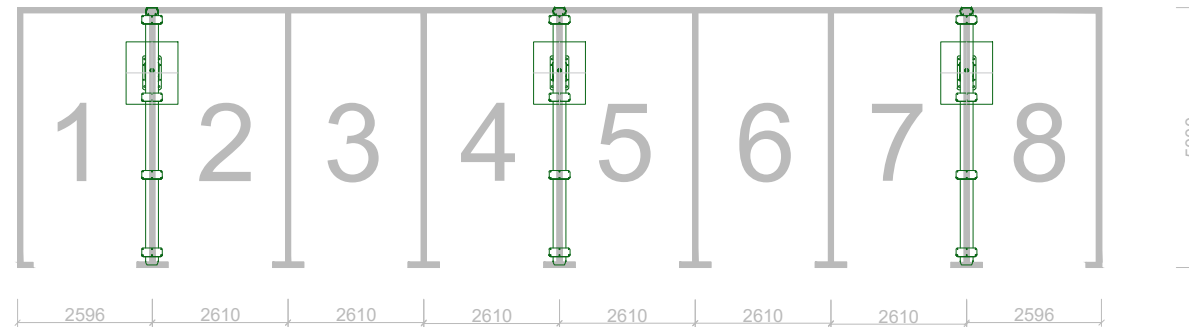
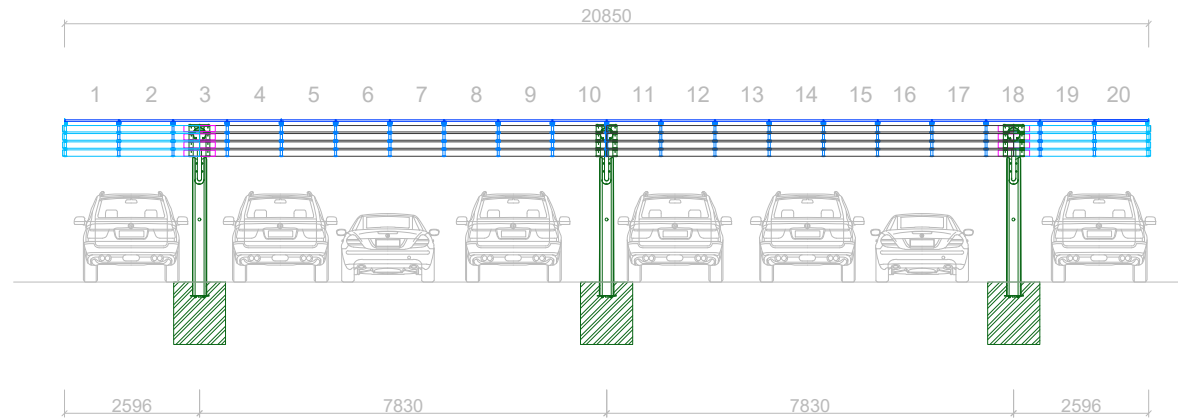

URVEN PARK - H

PILAR DE HORMIGÓN

GRIS OSCURO

VELA DE ACERO

EPOXI POLIAMIDA + POLIURETANO

ALIFATICO BLANCO BRILLO

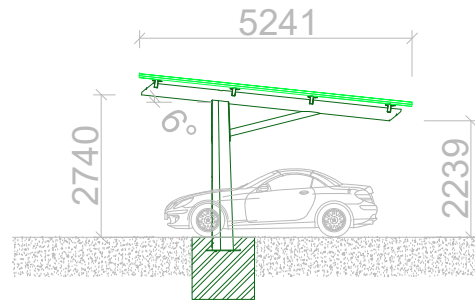

REFERENCIA: PKAB100000000

POTENCIA: 28,50 kWp

Nº MÓDULOS: 75

PLAZAS: 10

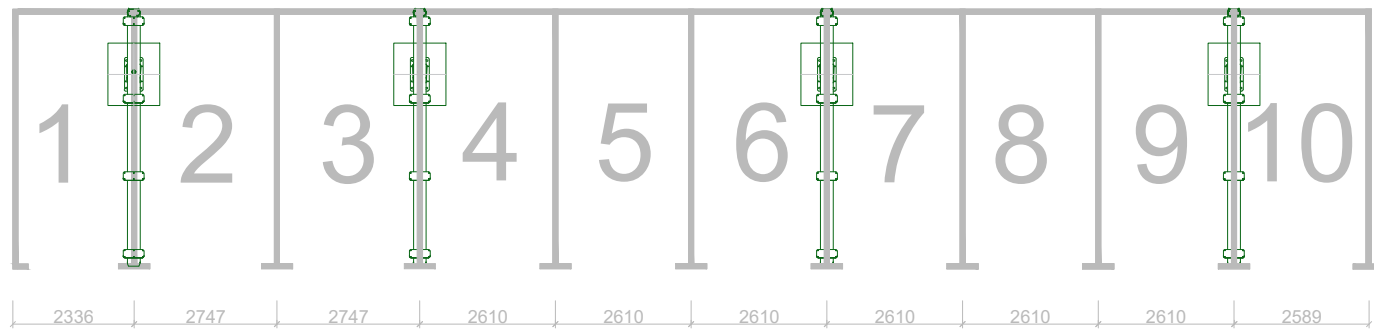
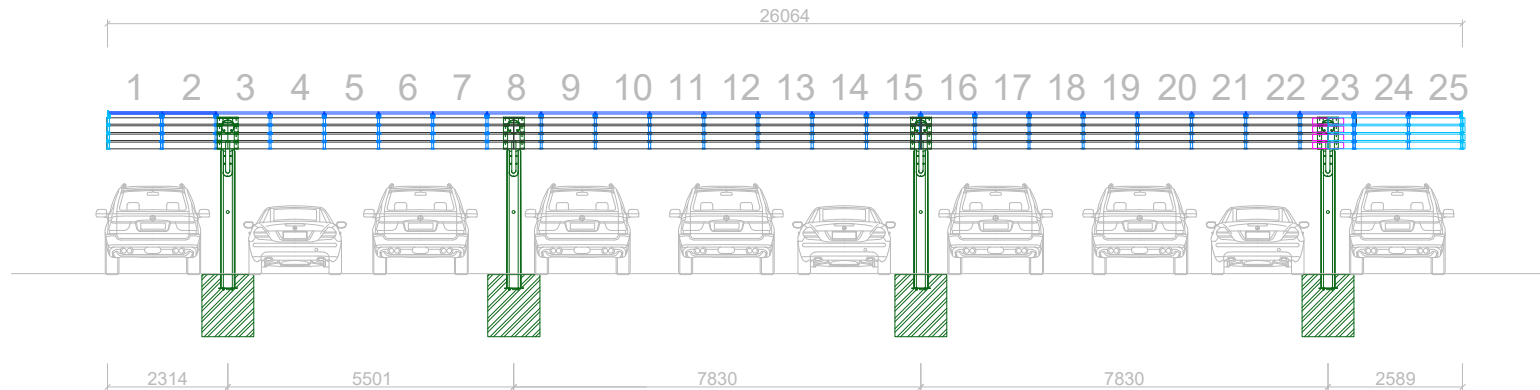

URVEN PARK - H

PILAR DE HORMIGÓN

GRIS OSCURO

VELA DE ACERO

EPOXI POLIAMIDA + POLIURETANO

ALIFATICO BLANCO BRILLO

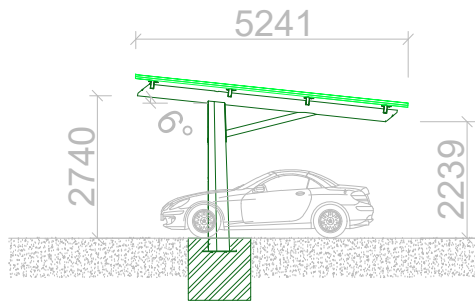

REFERENCIA: PKAB110000000

POTENCIA: 30,78 kWp

Nº MÓDULOS: 81

PLAZAS: 11

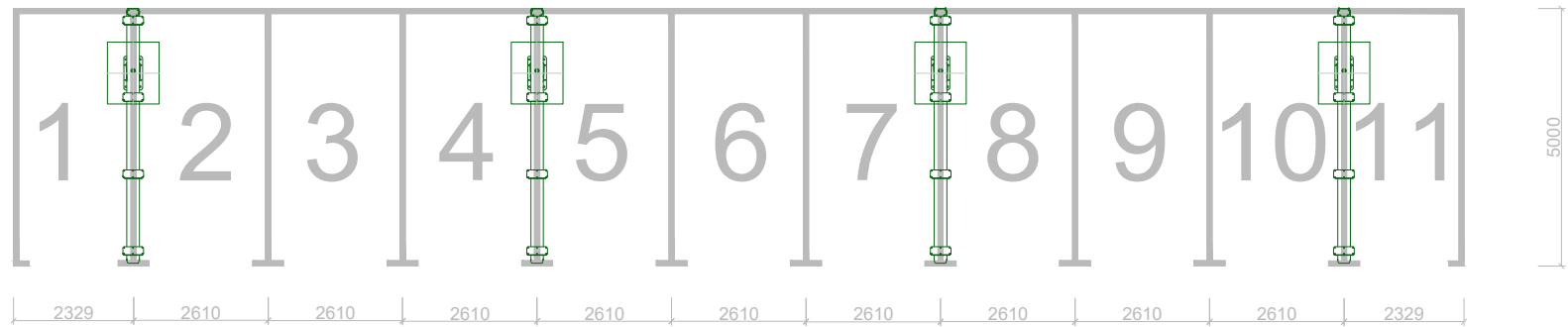
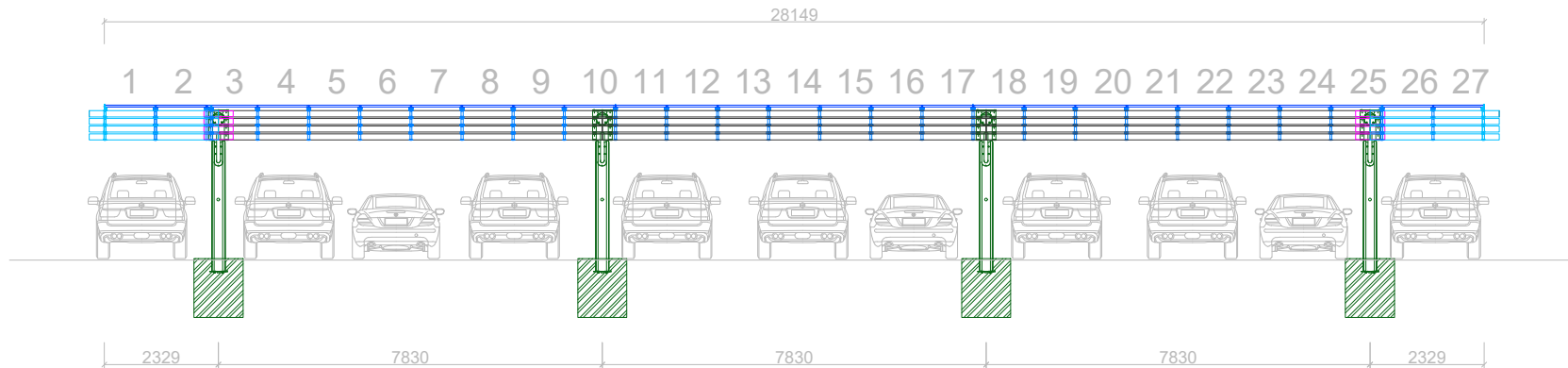

URVEN PARK - H

PILAR DE HORMIGÓN

GRIS OSCURO

VELA DE ACERO

EPOXI POLIAMIDA + POLIURETANO

ALIFATICO BLANCO BRILLO

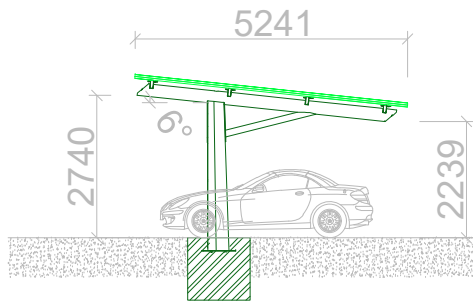

REFERENCIA: PKAB120000000

POTENCIA: 34,20 kWp

Nº MÓDULOS: 90

PLAZAS: 12

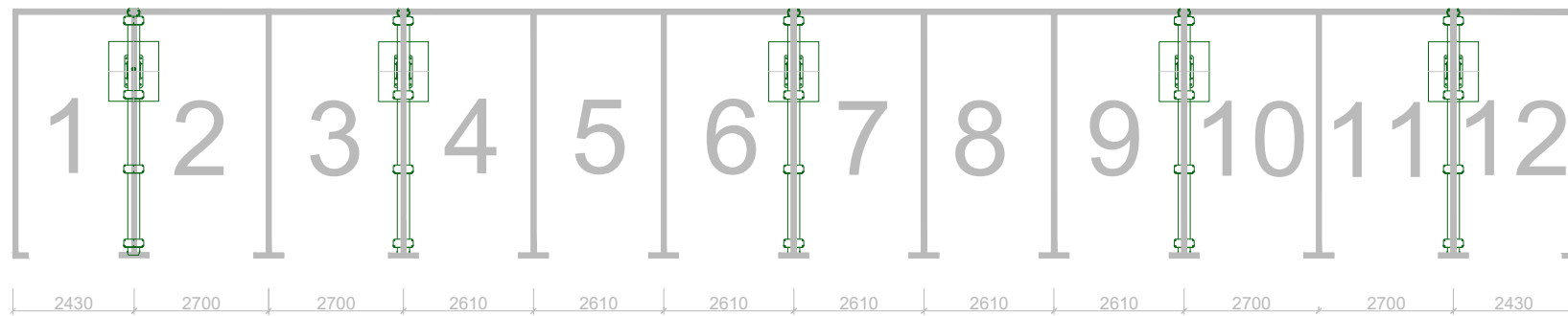
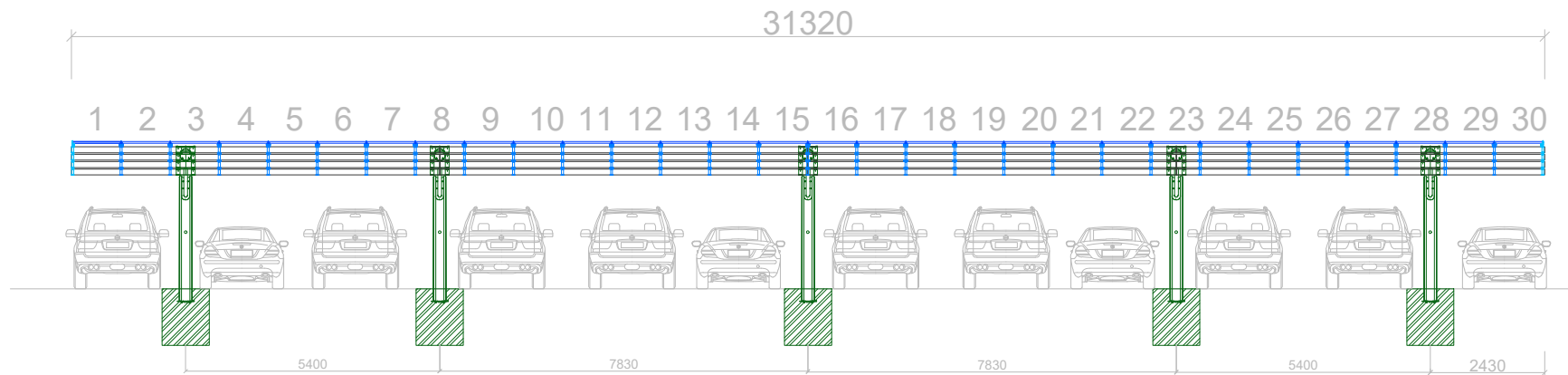

URVEN PARK - H

PILAR DE HORMIGÓN

GRIS OSCURO

VELA DE ACERO

EPOXI POLIAMIDA + POLIURETANO

ALIFATICO BLANCO BRILLO

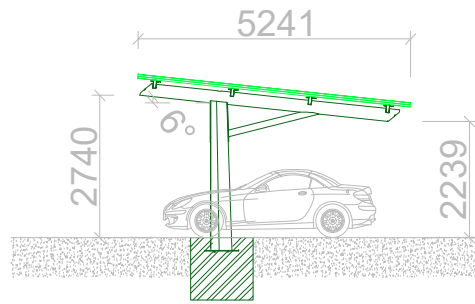

REFERENCIA: PKAB140000000
 POTENCIA: 39,90 kWp
 Nº MÓDULOS: 105
 PLAZAS: 14

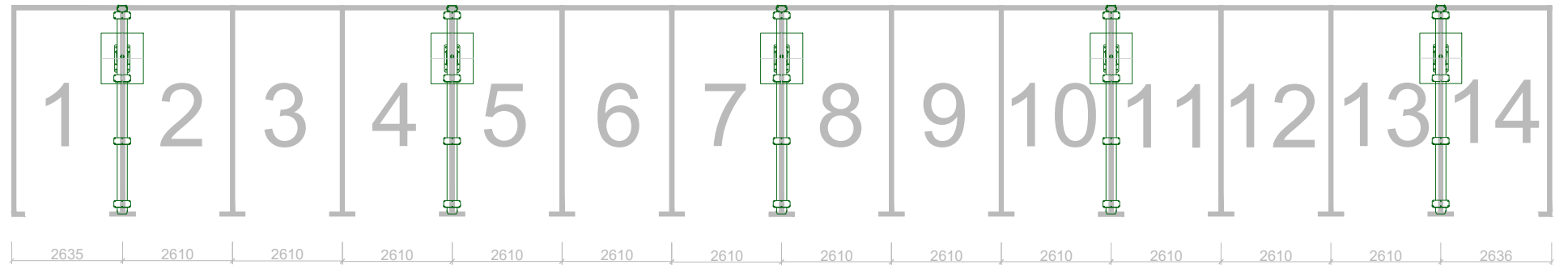
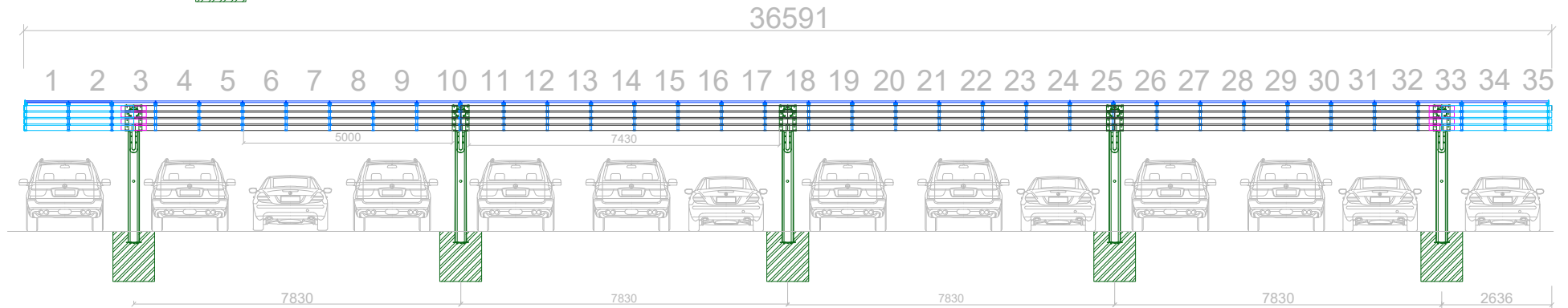

URVEN PARK - H

PILAR DE HORMIGÓN

GRIS OSCURO

VELA DE ACERO

EPOXI POLIAMIDA + POLIURETANO

ALIFATICO BLANCO BRILLO

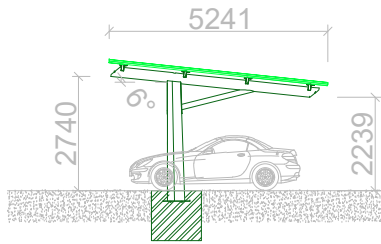

REFERENCIA: PKAB160000000

POTENCIA: 45,60 kWp

Nº MÓDULOS: 120

PLAZAS: 16

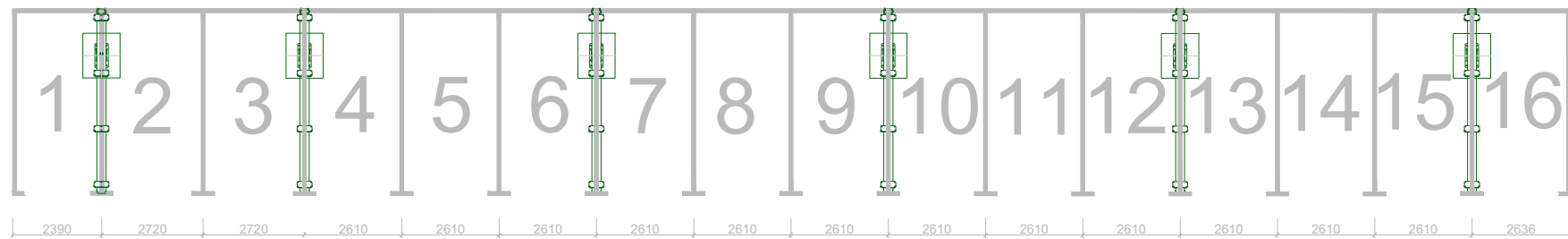
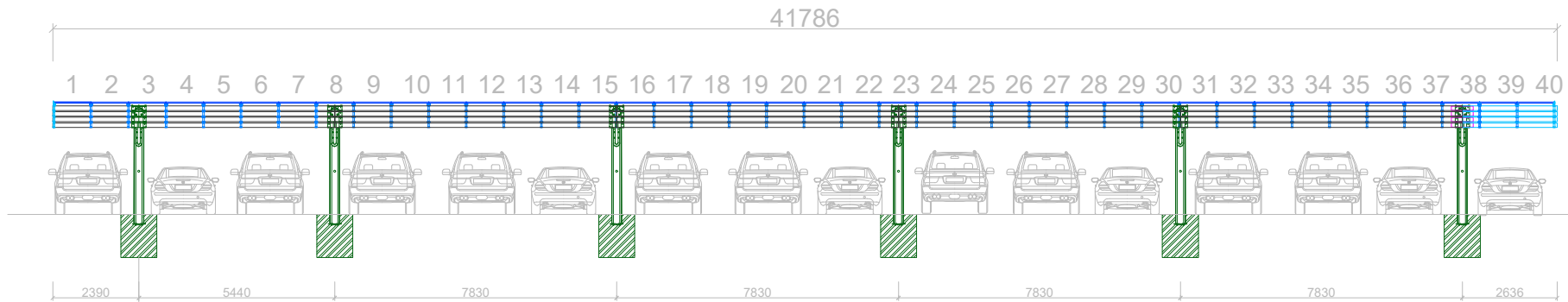

URVEN PARK - H

PILAR DE HORMIGÓN

GRIS OSCURO

VELA DE ACERO

EPOXI POLIAMIDA + POLIURETANO

ALIFATICO BLANCO BRILLO

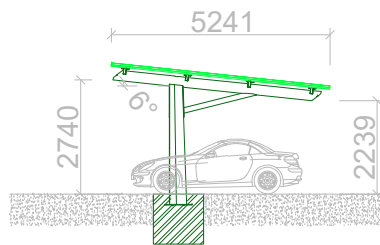

REFERENCIA: PKAB170000000

POTENCIA: 47,88 kWp

Nº MÓDULOS: 126

PLAZAS: 17

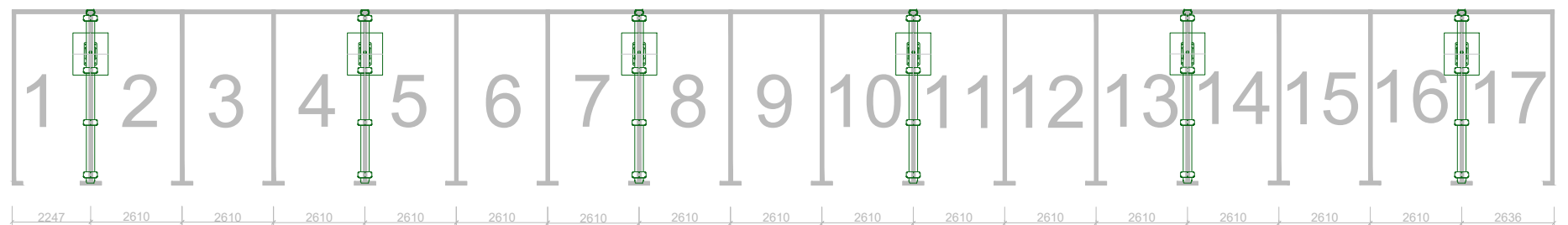
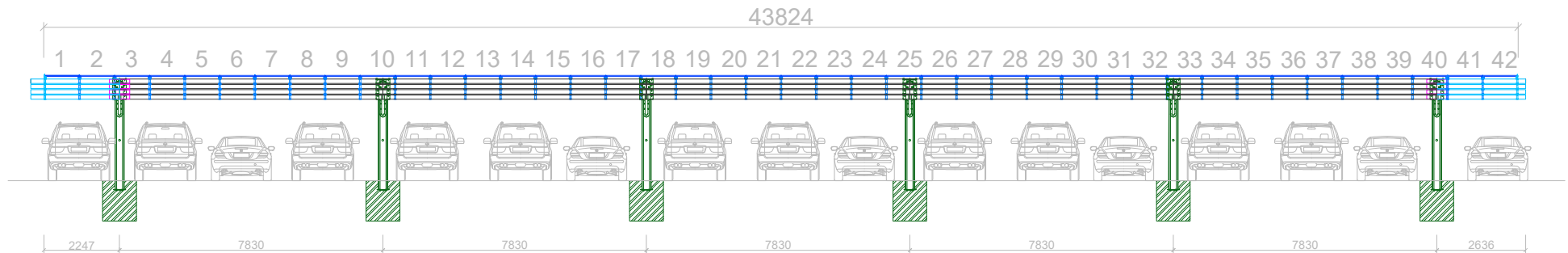

URVEN PARK - H

PILAR DE HORMIGÓN

GRIS OSCURO

VELA DE ACERO

EPOXI POLIAMIDA + POLIURETANO

ALIFATICO BLANCO BRILLO

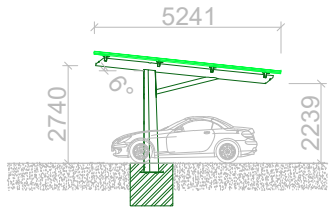

REFERENCIA: PKAB200000000
 POTENCIA: 47,88 kWp
 Nº MÓDULOS: 126
 PLAZAS: 17

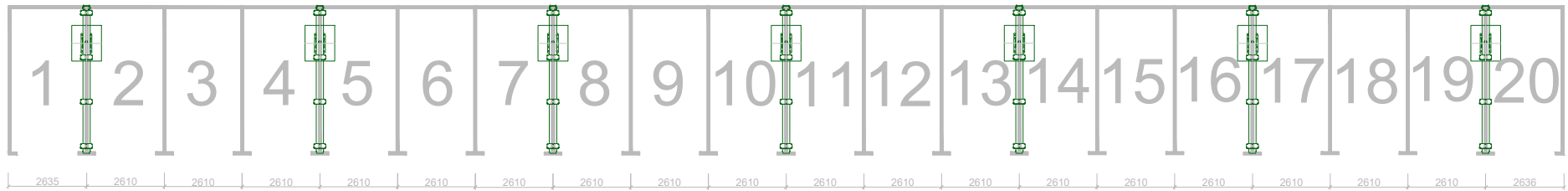
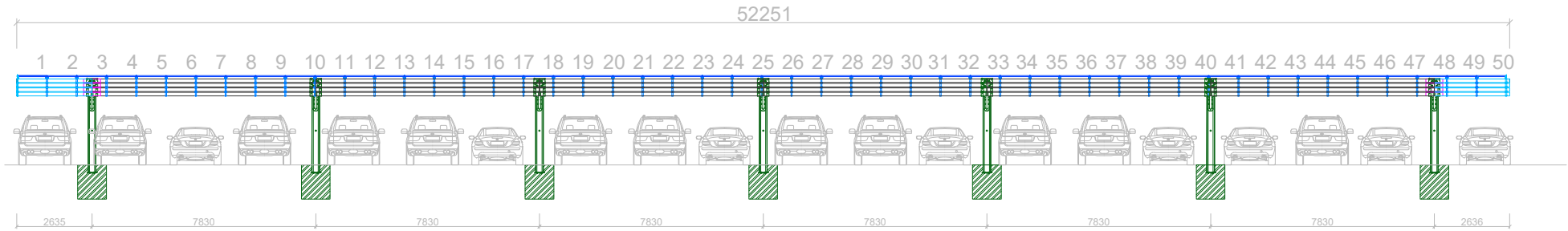

URVEN PARK - H

PILAR DE HORMIGÓN

GRIS OSCURO

VELA DE ACERO

EPOXI POLIAMIDA + POLIURETANO

ALIFATICO BLANCO BRILLO